

**Outline:
产品概要**

- Small size, high rated current, low DCR.
小尺寸，耐大电流，低直流电阻。
- Lead free product, RoHS compliant.
无铅产品，符合 RoHS 指令。
- Carrier tape packing, suitable for SMT process.
载带包装，适用于回流焊 SMT 工艺。
- Widely used in buck converter, displayer, laptop, network communication equipment, and etc.
广泛应用于升降压转换器，显示器，笔记本电脑，网络通信设备等。
- Operating temperature : -40°C ~ +125°C
(Including coil's temperature rise)
工作温度：-40°C ~ +125°C (包含线圈发热)

**1 Appearance and dimensions (mm)
外形尺寸**

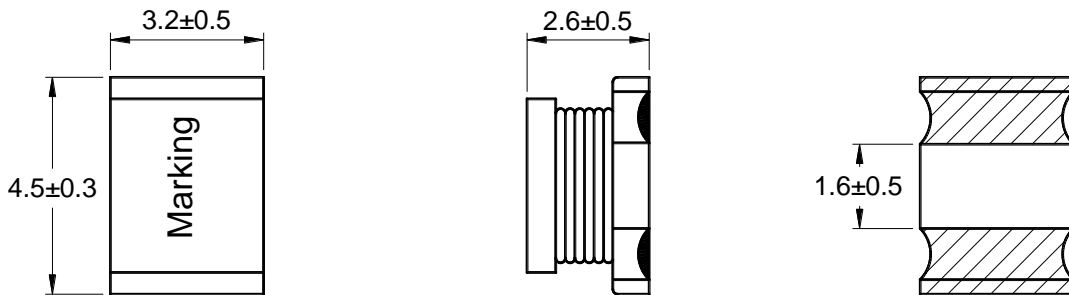

**2 Marking
印字标识**

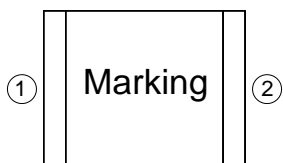

**3 Reference land pattern (mm)
参考基板尺寸**

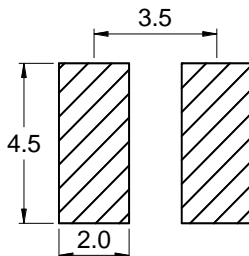

**4 Schematic
原理图**

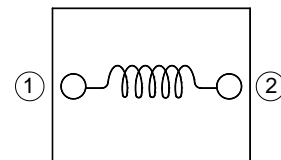

5 Electrical characteristics

电气特性

Part No. 型号	Inductance (μH) 电感值 ※1	D.C.R. (mΩ) 直流电阻		Saturation current (A) 饱和电流 ※2	Temperature rise current (A) 温升电流 ※3
		Typical	Max		
SPE453226-1R0M	1.00 ±20%	25.0	30.0	3.50	2.00
SPE453226-2R2M	2.20 ±20%	46.0	55.2	2.60	1.80
SPE453226-3R3M	3.30 ±20%	77.0	92.4	2.40	1.60
SPE453226-4R7M	4.70 ±20%	95.0	114	2.30	1.40
SPE453226-6R8M	6.80 ±20%	130	156	1.80	1.20
SPE453226-100K	10.0 ±10%	201	241	1.60	0.90
SPE453226-150K	15.0 ±10%	260	312	1.40	0.80
SPE453226-220K	22.0 ±10%	330	396	1.10	0.60
SPE453226-330K	33.0 ±10%	700	840	0.80	0.40
SPE453226-470K	47.0 ±10%	850	1,020	0.75	0.35
SPE453226-680K	68.0 ±10%	1,600	1,920	0.62	0.30
SPE453226-101K	100 ±10%	1,800	2,160	0.50	0.23
SPE453226-151K	150 ±10%	2,200	2,640	0.45	0.18
SPE453226-221K	220 ±10%	3,200	3,840	0.35	0.15

■ All data is tested based on 25°C ambient temperature.
所有数据基于环境温度 25°C条件下测试。

※1 Inductance measure condition at 1kHz, 0.25V.
电感测试条件为 1kHz, 0.25V。

※2 Saturation current: the actual value of DC current when the inductance decrease 20% of its initial value.
饱和电流: 电感值下降其初始值的 20%时所加载的实际直流电流值。

※3 Temperature rise current: the actual value of DC current when the temperature rise is ΔT40°C(Ta=25°C).
温升电流: 使产品温度上升到 ΔT40°C时所加载的实际直流电流值(Ta=25°C)。

※ Special remind: Circuit design, component placement, PWB size and thickness, cooling system and etc. all will affect the product temperature. Please verify the product temperature in the final application.
特别提醒: 线路设计, 组件布局, 印刷线路板(PWB)尺寸及厚度, 散热系统等均会影响产品温度。
请务必在最终应用时, 验证产品发热状况。

**6 Saturation current VS temperature rise current curve
饱和电流 VS 温升电流曲线**

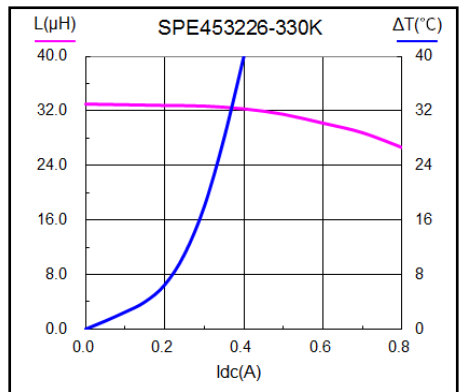
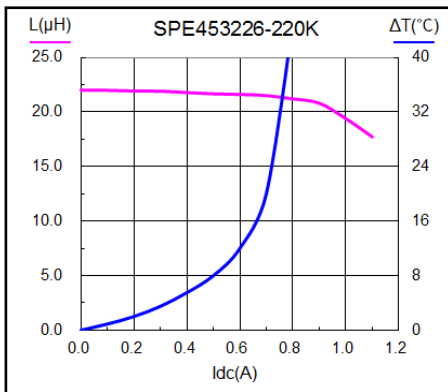
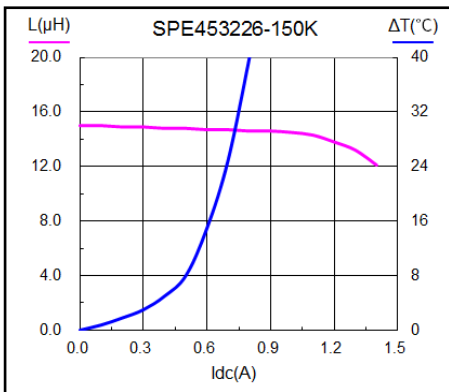
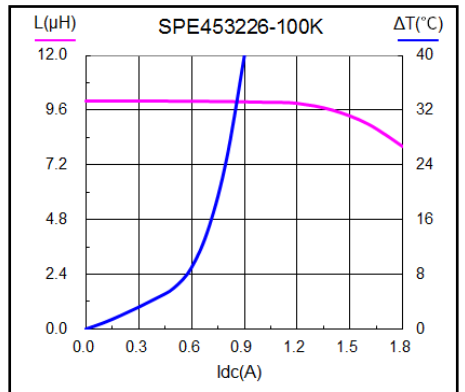
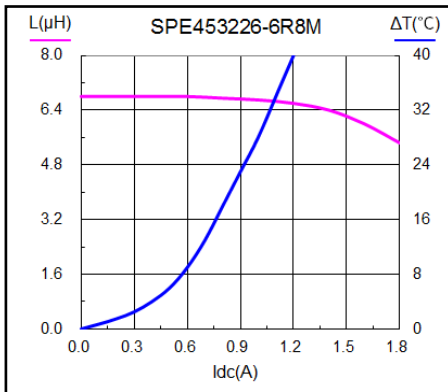
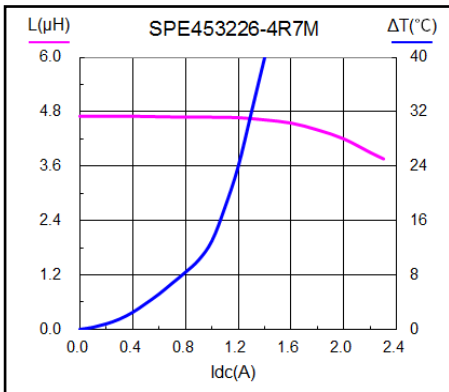
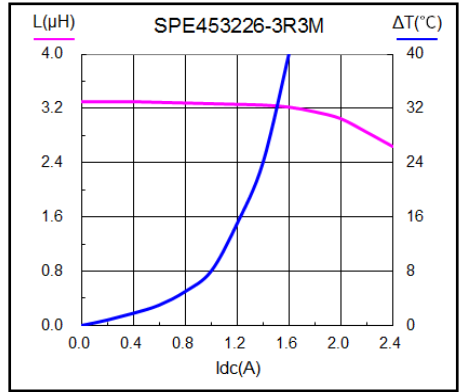
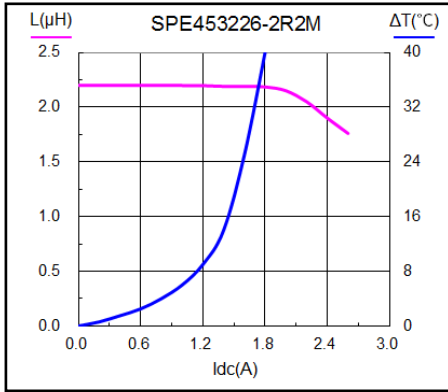
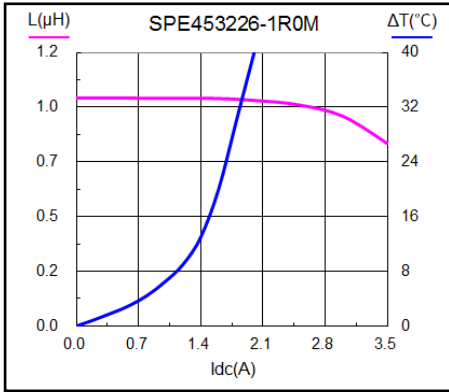

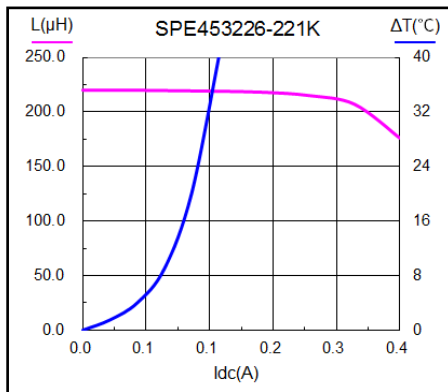
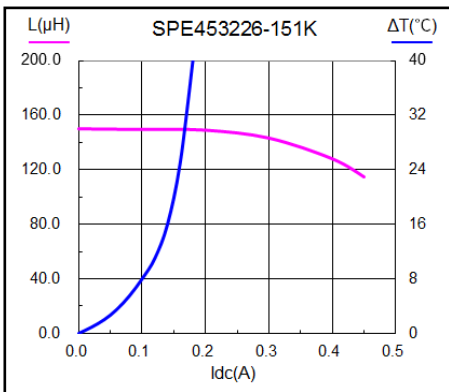
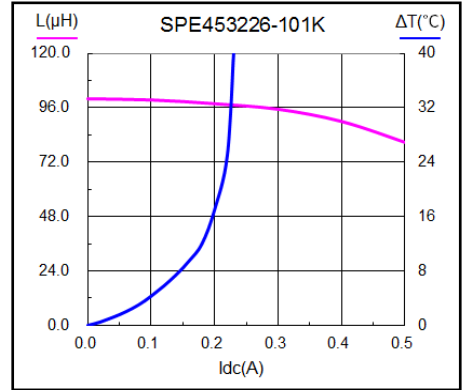
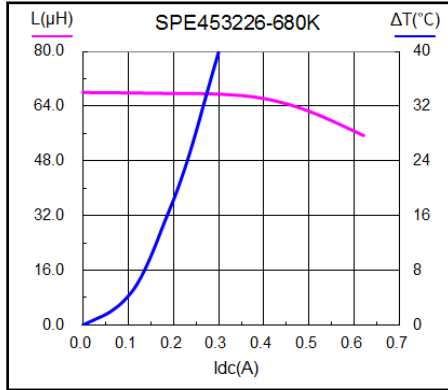
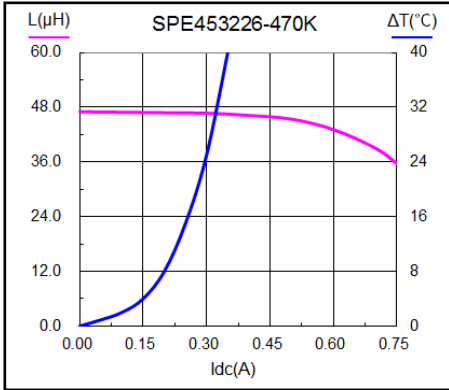

7 Packing specification

包装规格

7.1 Carrier tape dimensions (mm)

载带尺寸

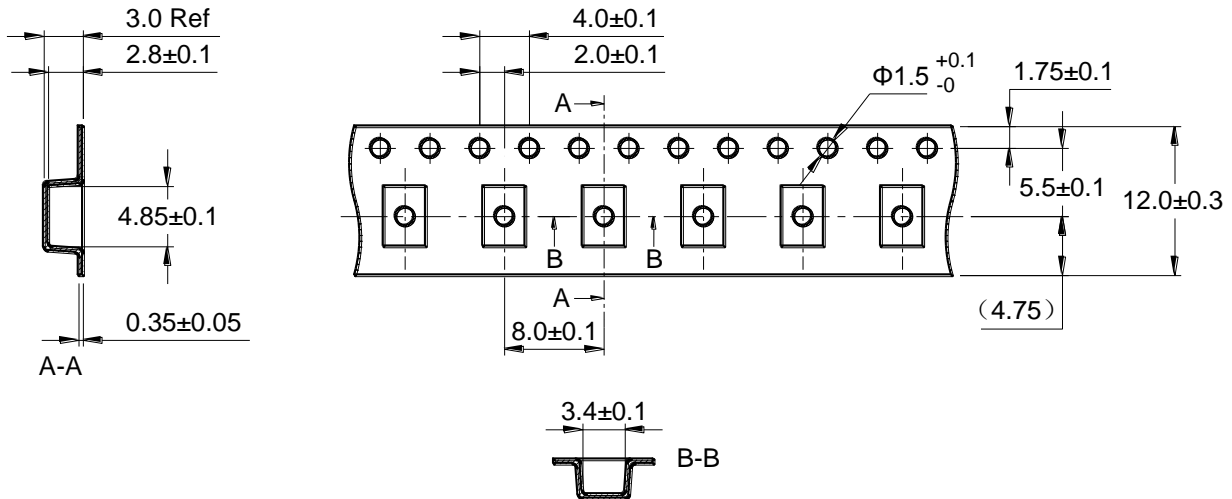

※ Packing is referred to the international standard IEC 60286-3.
包装参照国际标准 IEC 60286-3。

7.2 Tape direction

捆包方向

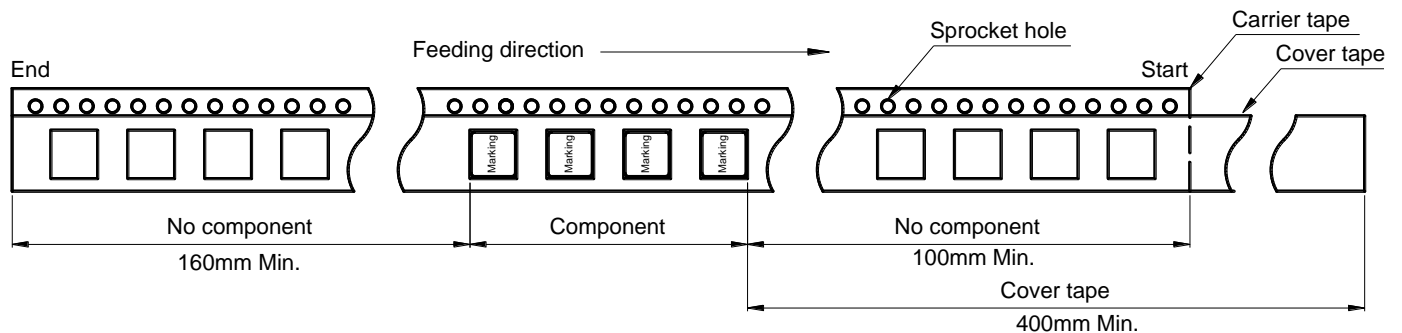

7.3 Cover tape peel off condition

盖带剥离条件

- Cover tape peel force shall be 0.1 to 1.3N.
盖带剥离力度为 0.1~1.3N。
- Reference peel speed 300±10mm/min.
参考剥离速度 300±10mm/分钟。

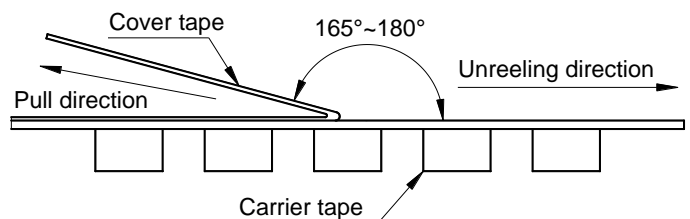

7.4 Reel dimensions (mm) 卷盘尺寸

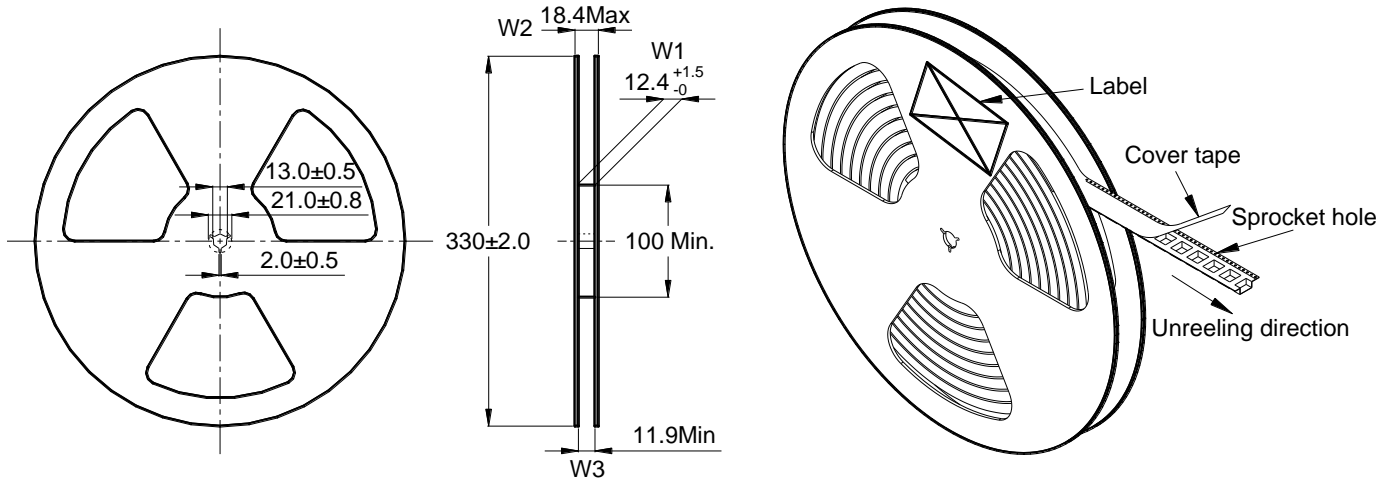

7.5 Carton dimensions 包装箱尺寸

- Inner Carton: 365×345×105mm
内包装盒
- Out Carton: 385×365×245mm
外包装箱

Product Series 产品系列	Quantity / Reel 数量 / 卷	Inner Carton Quantity 内盒 包装数量	Out Carton Quantity 外箱 总包装数量
SPE453226	2000pcs	10000pcs = (5×2000)	20000pcs = (2×10000)

7.6 Label making 标签标识

The following items will be marked on the reel of product label and shipping label.
以下项目将明确标识于产品卷盘标签以及运输标签上。

Production Label 产品标签
■ Part No. 产品型号
■ Electrical Information 产品电性信息
■ Quantity 数量
■ Packing No. 包装流水号

Shipping Label 运输标签
■ Customer Name 客户名称
■ Customer Part No. 客户型号
■ Supplier Part No. 供应商型号
■ Supplier Name 供应商名称
■ Country of origin 产品产地

8 Soldering specification

焊接规格

8.1 Reflow profile for SMT components

SMT 回流焊温度曲线

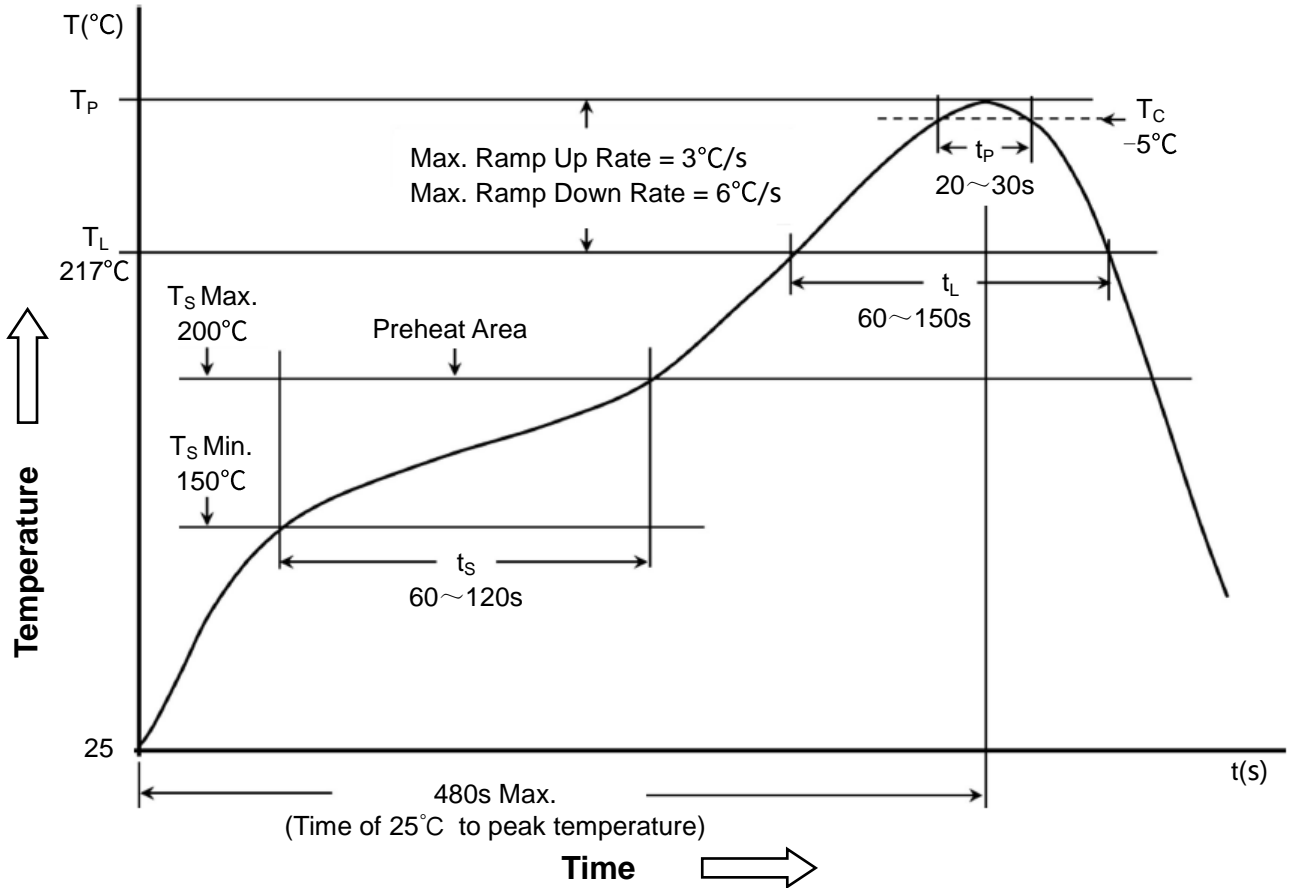

8.2 Classification of peak package body temperature (Tp)

封装体峰值温度(Tp)分类

	Package Thickness 封装厚度	Package Volume 封装体积		
		<350 mm ³	350~2000 mm ³	>2000 mm ³
PB-Free Assembly 无铅装配	<1.6mm	260°C	260°C	260°C
	1.6~2.5mm	260°C	250°C	245°C
	≥2.5mm	250°C	245°C	245°C

※ Reflow is referred to standard IPC/JEDEC J-STD-020D.
回流焊参照标准 IPC/JEDEC J-STD-020D。